



EURObox

19" EURObox Free Standing Cabinets

W=600mm EURObox Free Standing Cabinets

EURObox Free Standing cabinets are designed to perform for the best cost conduction to customers, with the strong and sturdy design, customer friendly assembly instructions, and superior logistical cost saving thanks to the intelligent flat packing mode.

Much more safer since not any detachable screw or hardware outside of cabinet.

The product is designed for network housing, in parallel functioning to mainly Security and Surveliance applications, audio video applications.

While product gives maximum performance in parallel provides a very valuable economy compared to its quality which is based on high technologic fully automated industry.

The 600 series is available in 6 heights from 16 through to 42U, and in certain sizes a choice of depth is also available including 600, 800 and 1000mm options. Each cabinet is supplied as standard with a glass front door, steel rear panel fixed side panels, front and rear are lockable.

The wide product height portfolio meets any U requirement in infrastructure needs.

EURObox series have a professional technical but aesthetic look with decorative Housing on the front door; the product range attracts the attention with the mostly environmentally fit and selected color of RAL 9005 Black, and RAL 7035 Light Grey, with fine wrinkle soft touch paint.

The product range allows with 1000mm depth versions, usage in private / low density server and storage applications.

Completely standard and stocked product portfolio, being delivered as un-assembled in flat pack, as shipping configuration the adjustable feet group is included.

EURObox series product range with optimal panel mounting size, and a variety range of accesories enclose the whole expectation of users.



CONSTRUCTION DETAILS:

Main Profile- Framework- Top/Bottom Cases and Roof:
Multi Folded Automated Bending technology applied monoblock side panel/frame system, provides a heavy duty structure results to high load capacity of: 600 kgs.

Monoblock multi folded top and bottom cases, tightly fixed to the side panel/frame system with fixing hardware , fully modular system generated.

Top case has a ready Forced Ventilation (Fan Module) integration housing.
Fan Module installation is from inside of enclosure

There are brushed cable entries on top for W600mm enclosures with 300x70mm

Bottom case integrated with Wide cable entry point provides maximum versatility. The rubber edged sliding mechanism on the cable entry point at bottom with w=350mxd=250mm allows large cabling infrastructure applications. On rubber edged sliding mechanism max cable entry opening is w=350xd=150mm. After inserting the cables, the rubber edged mechanism holds and fixes the cables in parallel preventing the cabinet from dust entry.

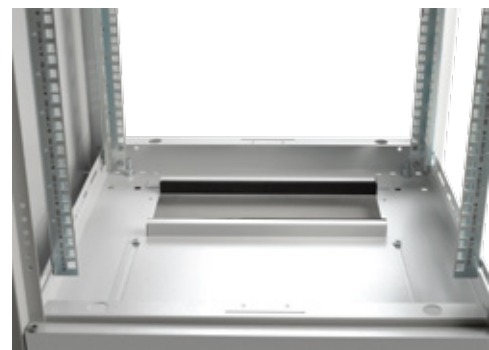
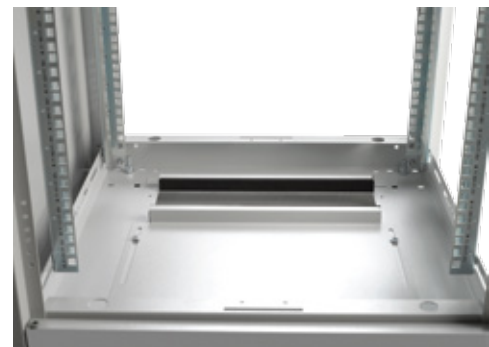
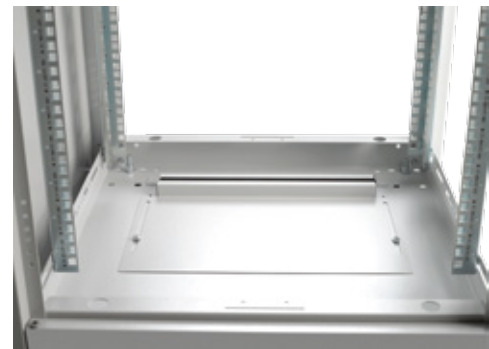

CONSTRUCTION DETAILS:

Access to enclosure:

Front door has a formed metal housing protecting the glass edges, full length smoked, shatterproof, antistatic, 4,0mm thickness glass with single point locking handled lock.

Decorative PVC Stripes charming the attraction with Green color for both RAL 7035 Light Grey Cabinets and for RAL 9005 Black cabinets

Front door opening direction is set right to left, but reversible to left to right at site with removing the hinge system. Hinge System is spring loaded easy operating version, which allows you to remove the whole front door from cabinet in seconds.

Side Panels are main load carrying frame of the cabinets, which is fixed to the top and bottom cases. This provides the economical offer, customer friendly assembly from flat pack delivery.

Side panels are monoblock multi formed single piece metal panel, strengthened with the side horizontal support bars connection frame to the 19" rails.

Rear Panels are lockable and removable with barrel style lock, Multifolded bending technology with 8 fold bending provides the rigidity. For best optimized cost conduction to customers, the rear panel designed and created easy lift of design and snap locking to the bottom case.



Side and rear view of cabinet

CONSTRUCTION DETAILS:

19" rails of EURObox Series Free Standing cabinets are with automated silk-screen U numbering, depends on size 1U to 42U, same from top to bottom or bottom to top results to same U height selection. No matter from where you have started counting. 19" rails are 4 fold bending surfaces, 1,5mm thickness provides the high load capacities. The 19" rails are made of steel with 8-12 micron zinc plating for corrosion resistance. 19" rails are adjustable in depth. For easy adjustment purpose, no need to detach the screws, just ease the screws and slide them in the channels on the top/bottom chassis bends.



Side Horizontal Support Bar in depth; up to 26U the 19" rails are fixed to just to and bottom case. Higher than 26U the cabinets are integrated with 1 set (left/right) , 1,5mm thickness Z type made of Steel + 8-12 micron zinc plated **side horizontal support bar**

All design features provide you strength and 2 way access to your enclosure and equipments, easy to reach to enclosure and equipments for all infrastructure installations and maintenance needs.



Width=600mm
Depth=600mm

Load Capacity: 600 kgs.

Standard Heights:

4 different U heights: 16U, 22U, 32U, 42U

Standards, and Compliances:



ISO 9001:2008
Quality Management System

EN 61587 -1:2012
Mechanical Structures for Electronic Equipment

IEC 297-1, 19" mounting
IEC 297-2 Overall cabinet dimensions



CE conform to
EN 60950-1:2006
Information Technology
Equipment – Safety – Part-1-
General Requirements



Environment Friendly;
*ISO 14001 Environmental
Management System
*RoHS compliancy
*% 100 Recyclable Material



EURObox Free Standing Cabinets, with 19" w:600mm and d:600mm physical sizes, with max internal usable depth, and 4 different height, gives a wide selection chart for users.

Standard Colors:

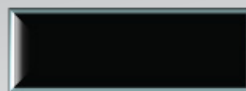

RAL 9005 Black

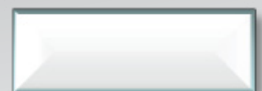

RAL 7035 Light Grey

19" EURObox Cabinets

W:600mm D:600mm Drawings

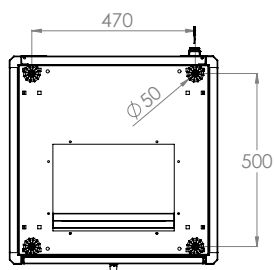

BOTTOM VIEW

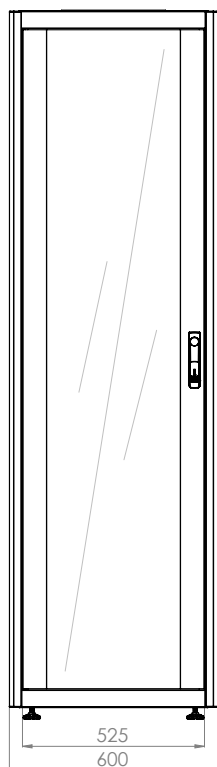

FRONT VIEW

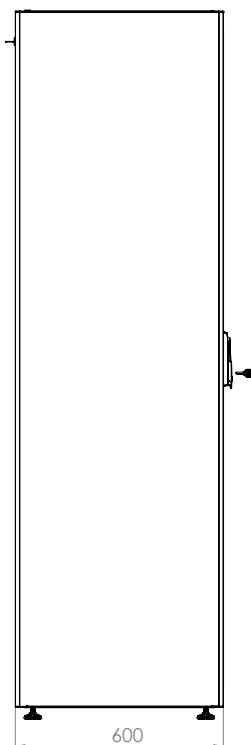

SIDE VIEW

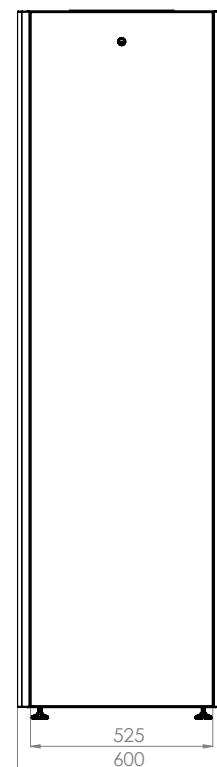

REAR VIEW

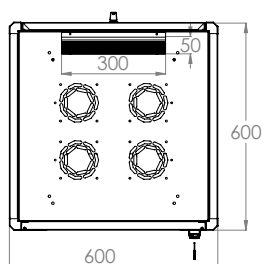

TOP VIEW

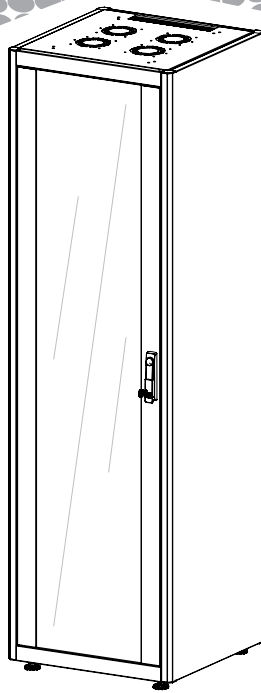

ISOMETRIC VIEW

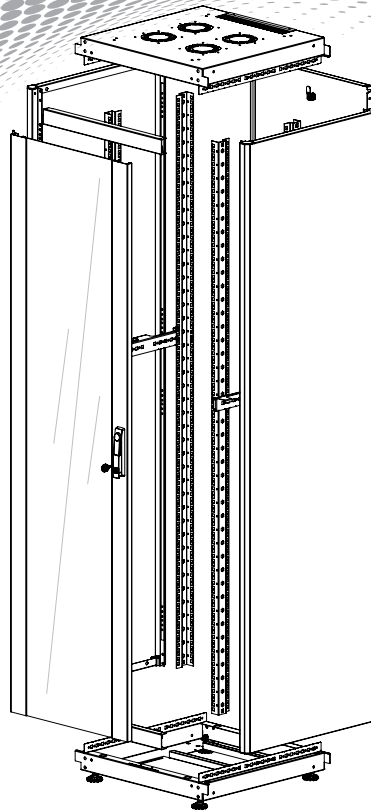

EXPLODED VIEW

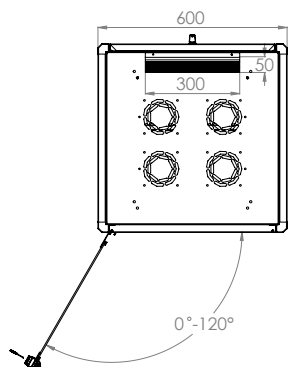

FRONT DOOR OPENING ANGLE

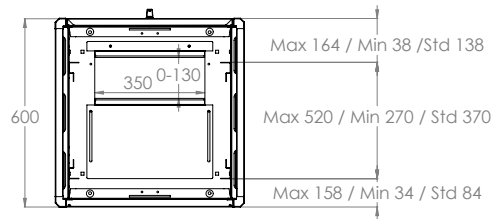

MAX/STD/MIN EQUIPMENT MOUNTING DISTANCE

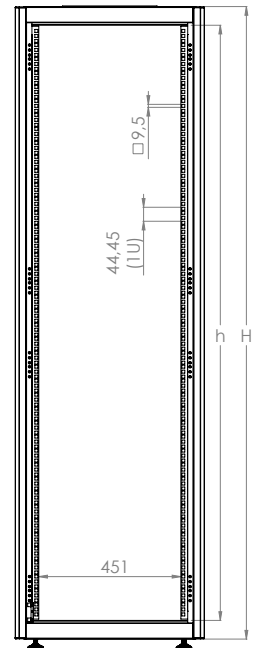

DIMENSIONS IN WIDTH AND HEIGHT

EURObox Series Free Standing 19" Cabinets W=600mm D=600mm

ROOT Product Number ***	Product Description	Size WxDXH mm	h size in U	h in mm	*H mm, overall without feet and/or castor	Width Overall mm	Width Rail to Rail mm	Depth Overall mm	**Depth Shipping Conf. Rail to Rail mm	QTY IN PACKAGE	PACKING DIMENSIONS WxDXH mm	Standard NET Weight of product kgs	Gross Weight of Product kgs	QTY IN PALLETTE	PALETTE DIMENSIONS WxDXH mm	Palette Weight kgs
LN-EUBOX16U6060-LG	16U 19" Free Standing Cabinet W=600mm D=600mm	600x600x855	16U	711	855	600	19"	600	370	1	1300x780x250	34	42	7	1300x830x1900	248
LN-EUBOX22U6060-LG	22U 19" Free Standing Cabinet W=600mm D=600mm	600x600x1121	22U	978	1121	600	19"	600	370	1	1300x780x250	41	49	7	1300x830x1900	297
LN-EUBOX32U6060-LG	32U 19" Free Standing Cabinet W=600mm D=600mm	600x600x1565	32U	1422	1565	600	19"	600	370	1	1700x780x220	53	70	8	1700x830x1950	439
LN-EUBOX42U6060-LG	42U 19" Free Standing Cabinet W=600mm D=600mm	600x600x2010	42U	1867	2010	600	19"	600	370	1	2150x780x220	65	81	8	2150x830x1950	540

*** Standard Supply is in Flat pack and RAL 7035 light Grey Color, incase requested Black put BL instead of LG, incase assembled product request, put A notification at the end of part number, ie LN-EUBOX16U6060-LG -A, unless defined light Grey-Flat pack product will be shipped

19" EURObox Free Standing Cabinets

Width:600mm depth:800mm



Width=600mm
Depth=800mm

Load Capacity: 600 kgs.

Standard Heights:

4 different U heights: 16U, 22U, 32U, 42U

Standards, and Compliances:



ISO 9001:2008

Quality Management System

EN 61587 -1:2012

Mechanical Structures for Electronic Equipment

IEC 297-1, 19" mounting

IEC 297-2 Overall cabinet dimensions



CE conform to

EN 60950-1:2006

Information Technology

Equipment – Safety – Part-1-

General Requirements



Environment Friendly;

*ISO 14001 Environmental
Management System

*RoHS compliancy

*% 100 Recyclable Material



EURObox Free Standing Cabinets, with 19" w:600mm and d:800mm physical sizes, with max internal usable depth, and 4 different height, gives a wide selection chart for users.

Standard Colors:

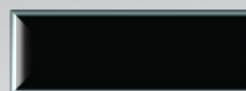

RAL 9005 Black

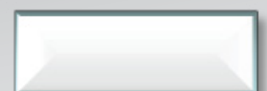

RAL 7035 Light Grey

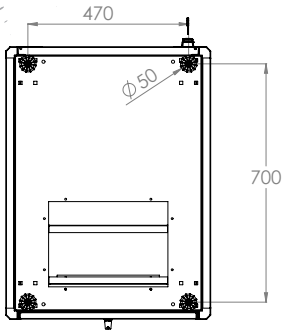

BOTTOM VIEW

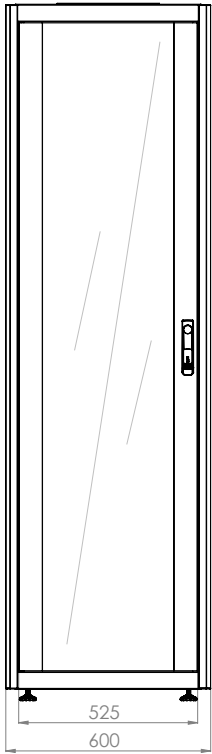

FRONT VIEW

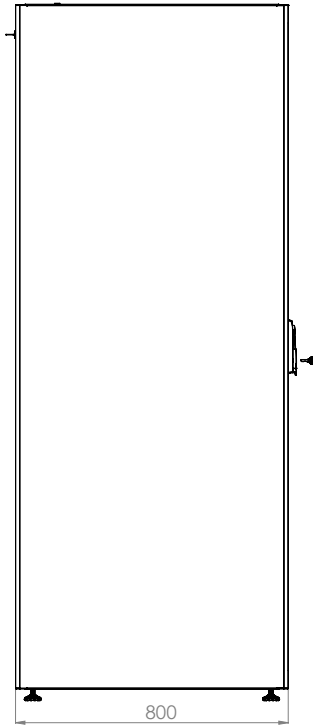

SIDE VIEW

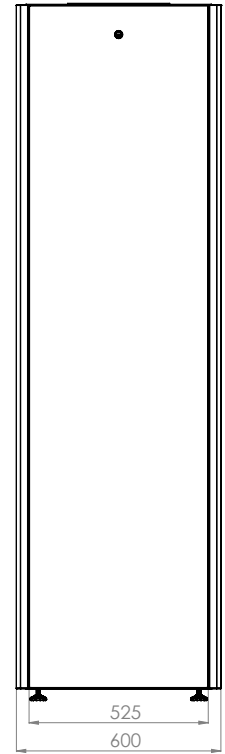

REAR VIEW

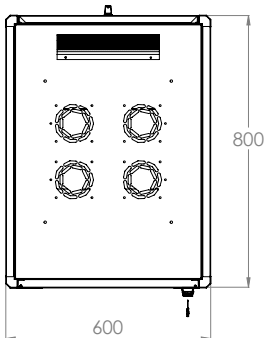

TOP VIEW

19" EURObox Cabinets

W:600mm D:800mm Drawings

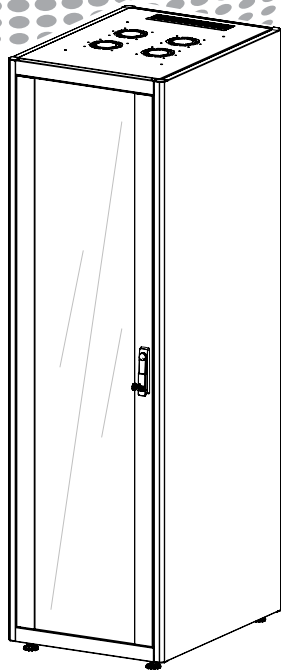

ISOMETRIC VIEW

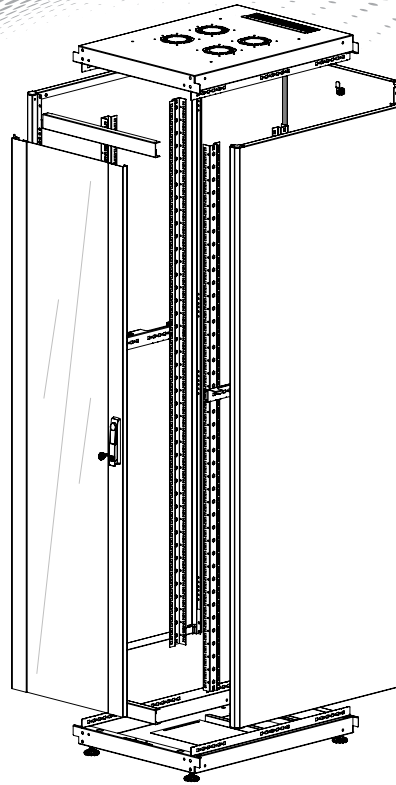

EXPLODED VIEW

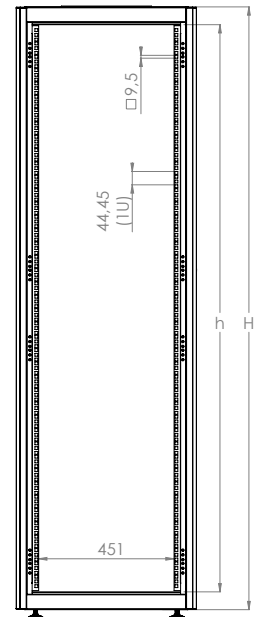

DIMENSIONS
IN
WIDTH HEIGHT

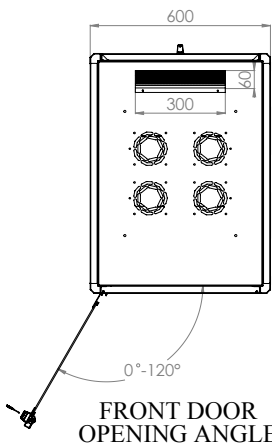

FRONT DOOR
OPENING ANGLE

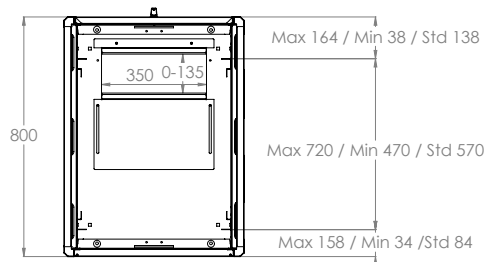

MAX/STD/MIN/EQUIPMENT
MOUNTING DISTANCE

EURObox Series Free Standing 19" Cabinets W=600mm D=800mm

ROOT Product Number ***	Product Description	Size WxDxH mm	h size in U	h in mm	*H mm, overall without feet and/or castor	Width Overall mm	Width Rail to Rail mm	Depth Overall mm	**Depth Shipping Conf. Rail to Rail mm	QTY IN PACKAGE	PACKING DIMENSIONS WxDxH mm	Standard NET Weight of product kgs	Gross Weight of Product kgs	QTY IN PALLETTE	PALETTE DIMENSIONS WxDxH mm	Palette Weight kgs
LN-EUBOX16U6080-LG	16U 19" Free Standing Cabinet W=600mm D=800mm	600x600x855	16U	711	855	600	19"	800	570	1	1300x980x250	42	82	7	1300x1030x1900	309
LN-EUBOX22U6080-LG	22U 19" Free Standing Cabinet W=600mm D=800mm	600x600x1121	22U	978	1121	600	19"	800	570	1	1300x980x250	50	60	7	1300x1030x1900	365
LN-EUBOX32U6080-LG	32U 19" Free Standing Cabinet W=600mm D=800mm	600x600x1565	32U	1422	1565	600	19"	800	570	1	1700x980x220	63	75	8	1700x1030x1950	522
LN-EUBOX42U6080-LG	42U 19" Free Standing Cabinet W=600mm D=800mm	600x600x2010	42U	1867	2010	600	19"	800	570	1	2150x980x220	77	91	8	2150x1030x1950	646

*** Standard Supply is in Flat pack and RAL 7035 light Grey Color, incase requested Black put BL instead of LG, incase assembled product request, put A notification at the end of part number, ie

LN-EUBOX16U6080-LG -A, unless defined light Grey-Flat pack product will be shipped

Width=600mm
Depth=1000mm

Load Capacity: 600 kgs.

Standard Heights:

3 different U heights: 26U, 36U, 42U

Standards, and Compliances:



ISO 9001:2008
Quality Management System

EN 61587 -1:2012
Mechanical Structures for Electronic Equipment

IEC 297-1, 19" mounting
IEC 297-2 Overall cabinet dimensions



CE conform to
EN 60950-1:2006
Information Technology
Equipment – Safety – Part-1-
General Requirements



Environment Friendly;
*ISO 14001 Environmental
Management System
*RoHS compliancy
*% 100 Recyclable Material



EURObox Free Standing Cabinets, with 19" w:600mm and d:1000mm physical sizes, with max internal usable depth, and 3 different height, gives a wide selection chart for users.

Standard Colors:

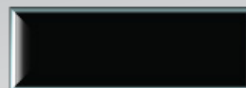

RAL 9005 Black

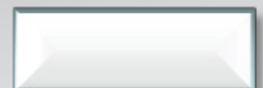

RAL 7035 Light Grey

19" EURObox Cabinets

W:600mm D:1000mm Drawings

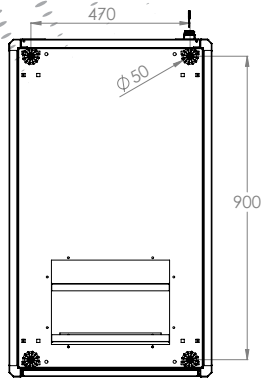

BOTTOM VIEW

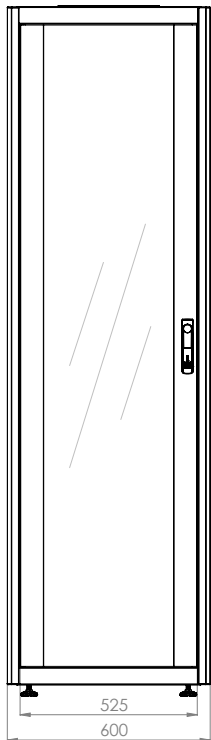

FRONT VIEW

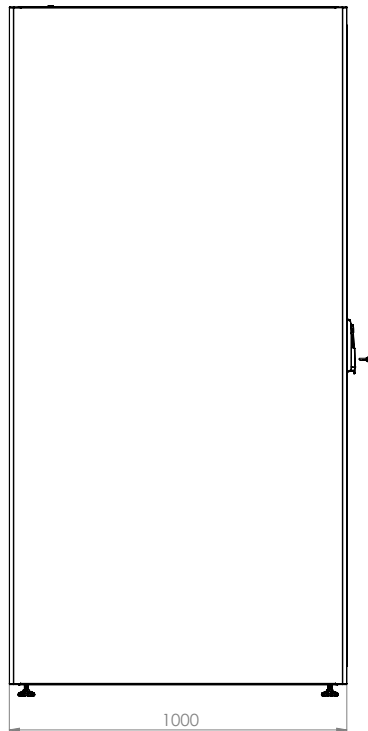

SIDE VIEW

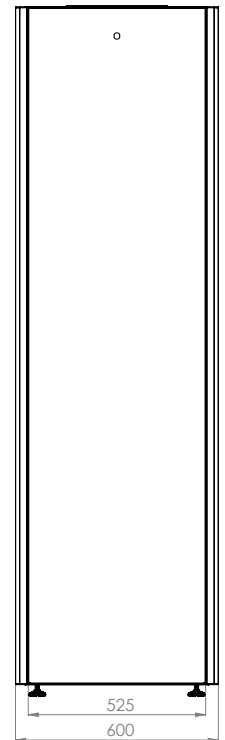

REAR VIEW

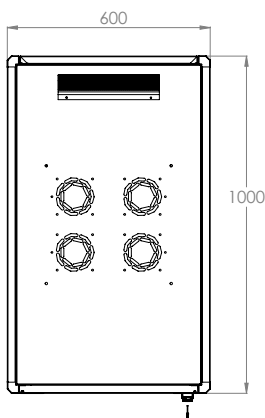

TOP VIEW

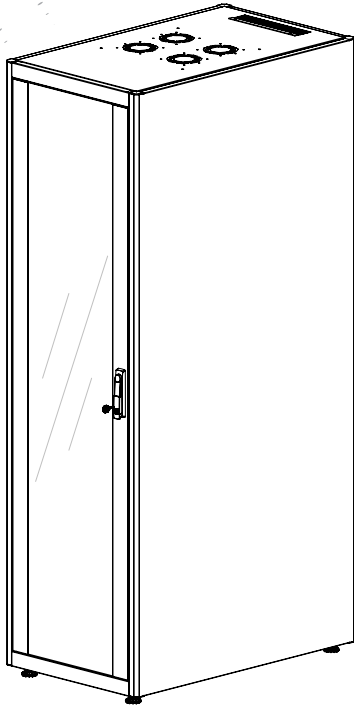

ISOMETRIC VIEW

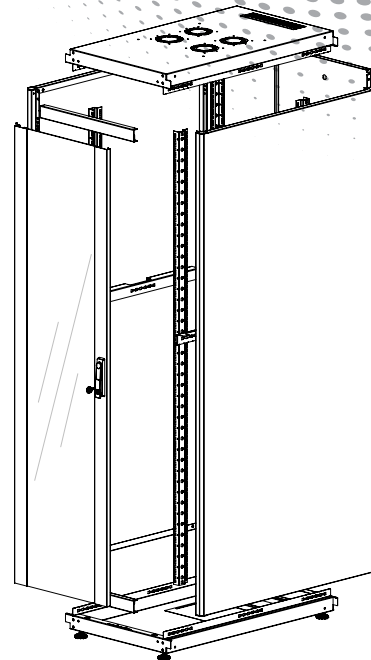

EXPLODED VIEW

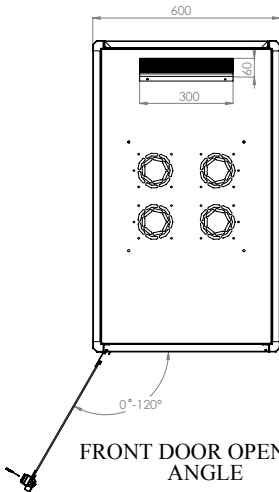

FRONT DOOR OPENING ANGLE

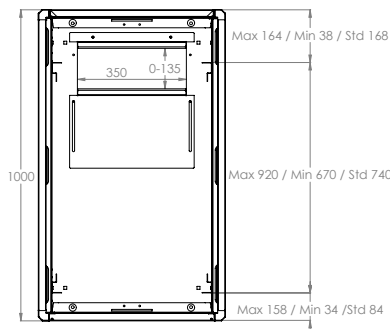

MAX/STD/MIN EQUIPMENT MOUNTING DISTANCE

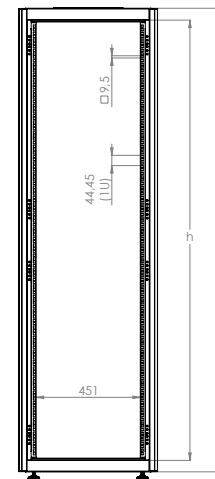

DIMENSIONS IN WIDTH AND HEIGHT

EURObox Series Free Standing 19" Cabinets W=600mm D=1000mm

ROOT Product Number ***	Product Description	Size WxDxH mm	h size in U	h in mm	*H mm, overall without feet and/or castor	Width Overall mm	Width Rail to Rail mm	Depth Overall mm	**Depth Shipping Conf. Rail to Rail mm	QTY IN PACKAGE	PACKING DIMENSIONS WxDxH mm	Standard NET Weight of product kgs	Gross Weight of Product kgs	QTY IN PALETTE	PALETTE DIMENSIONS WxDxH mm	Palette Weight kgs
LN-EUBOX26U6010-LG	26U 19" Free Standing Cabinet W=600mm D=800mm	600x600x1299	26U	1156	1299	600	19"	1000	770	1	1520x1140x240	62	74	6	1520x1170x1600	390
LN-EUBOX36U6010-LG	36U 19" Free Standing Cabinet W=600mm D=800mm	600x600x1743	36U	1600	1743	600	19"	1000	770	1	1830x1140x240	76	81	6	1830x1170x1600	476
LN-EUBOX42U6010-LG	42U 19" Free Standing Cabinet W=600mm D=800mm	600x600x2010	42U	1867	2010	600	19"	1000	770	1	2150x1140x240	85	105	6	2150x1170x1600	545

*** Standard Supply is in Flat pack and RAL 7035 light Grey Color, incase requested Black put BL instead of LG, incase assembled product request, put A notification at the end of part number, ie LN-EUBOX26U6010-LG-A, unless defined light Grey-Flat pack product will be shipped

W=800mm EURObox Free Standing Cabinets are carrying the same constructional features of W=600mm segment with additional features for mass cabling infrastructure needs.

Which vertical Cable management Panels in front 1Set-2pcs is an option.

For mass cabling insertion, there are also additional 300x55 brushed cable entry panels at sides of top and bottom case.

EURObox Free Standing cabinets are designed to perform for the best cost conduction to customers, with the strong and sturdy design, customer friendly assembly instructions, and superior logistical cost saving thanks to the intelligent flat packing mode

Much more safer since not any detachable screw or hardware outside of cabinet.

The product is designed for network housing, in parallel functioning to mainly Security and Surveliance applications, audio video applications.

While product gives maximum performance in parallel provides a very valuable economy compared to its quality which is based on high technologic fully automated industry.

The W800mm Cabinet is available with the most common selected size of 42U W800xD800mm

EURObox series have a professional technical but aesthetic look with decorative Housing on the front door; the product range attracts the attention with the mostly environmentally fit and selected color of RAL 9005 Black, and RAL 7035 Light Grey, with fine wrinkle soft touch paint.

Completely standard and stocked product portfolio, being delivered as un-assembled in flat pack, as shipping configuration the adjustable feet group is included.

EURObox series product range with optimal panel mounting size, and a variety range of accesories enclose the whole expectation of users.



CONSTRUCTION DETAILS:

Main Profile- Framework- Top/Bottom Cases:
Multi Folded Automated Bending technology applied corner profile system, provides a heavy duty structure results to high load capacity of: 600 kgs.

Monoblock multi folded top and bottom cases, tightly fixed to the framework with fixing hardware , fully modular system generated.

Top case has a ready Forced Ventilation (Fan Module) integration housing.

Additionally top and bottom case have large cable entries, 3 pcs on top case, and 3 pcs on bottom case, with size of 300x70mm

Bottom case integrated with Wide cable entry point provides maximum versatility. The rubber edged sliding mechanism on the cable entry point at bottom with w=350mmd=250mm allows large cabling infrastructure applications. On rubber edged sliding mechanism max cable entry opening is w=350xd=150mm. After inserting the cables, the rubber edged mechanism holds and fixes the cables in parallel preventing the cabinet from dust entry.

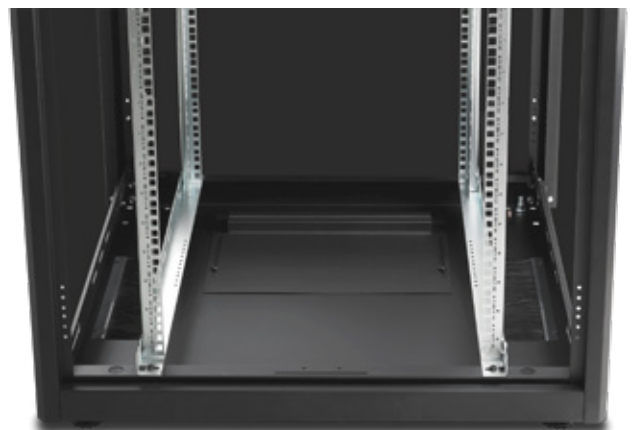

CONSTRUCTION DETAILS:

Access to enclosure:

Front door has a formed metal housing protecting the glass edges, full length smoked, shatterproof, antistatic, 4,0mm thickness glass with single point locking handled lock.

Decorative PVC Stripes charming the attraction with Green color for both RAL 7035 Light Grey Cabinets and for RAL 9005 Black cabinets

Front door opening direction is set right to left, but reversible to left to right at site with removing the hinge system. Hinge System is spring loaded easy operating version, which allows you to remove the whole front door from cabinet in seconds.

Side Panels are main load carrying frame of the cabinets, which is fixed to the top and bottom cases.

This provides the economical offer, customer friendly assembly from flat pack delivery.

Side panels are monoblock multi formed single piece metal panel, strengthened with the side horizontal support bars connection frame to the 19" rails.



Rear Panels are lockable and removable with barrel style lock, Multifolded bending technology with 8 fold bending provides the rigidity. For best optimized cost conduction to customers, the rear panel designed and created easy lift of design and snap locking to the bottom case.



CONSTRUCTION DETAILS:

19" rails of Digitus EURObox Series Free Standing cabinets are with automated silk-screen U numbering, depends on size 1U to 42U, same from top to bottom or bottom to top results to same U height selection. No matter from where you have started counting. 19" rails are 4 fold bending surfaces, 1,5mm thickness provides the high load capacities. The 19" rails are made of steel with 8-12 micron zinc plating for corrosion resistance. 19" rails are adjustable in depth. For easy adjustment purpose, no need to detach the screws, just ease the screws and slide them in the channels on the top/bottom chasis bends.

Side Horizontal Support Bar in depth; integrated with 1 set (left/right) , 1,5mm thickness Z type made of Steel + 8-12 micron zinc plated side horizontal support bar

All design features provide you strength and 2 way access to your enclosure and equipments, easy to reach to enclosure and equipments for all infrastructure installations and maintenance needs.



19" EURObox Free Standing Cabinets

Width:800mm depth:800mm



Width=800mm
Depth=800mm

Load Capacity: 600 kgs.

Standard Height: 42U

Standards, and Compliances:



ISO 9001:2008
Quality Management System

EN 61587 -1:2012
Mechanical Structures for Electronic Equipment

IEC 297-1, 19" mounting
IEC 297-2 Overall cabinet dimensions



CE conform to
EN 60950-1:2006
Information Technology
Equipment – Safety – Part-1-
General Requirements



Environment Friendly;
*ISO 14001 Environmental
Management System
*RoHS compliancy
*% 100 Recyclable Material



EURObox series Networking / Cabling Free Standing Cabinets, with 19" w:800mm and d:800mm physical sizes, with max internal usable depth gives the better cabling infrastructure.

Possible to integrate Vertical Cable Management Panel for better management of mass cabling inside the enclosure.

Standard Colors:

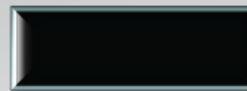

RAL 9005 Black

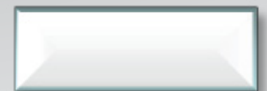

RAL 7035 Light Grey

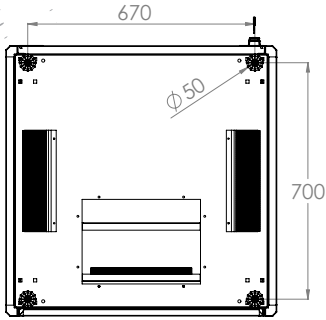

BOTTOM VIEW

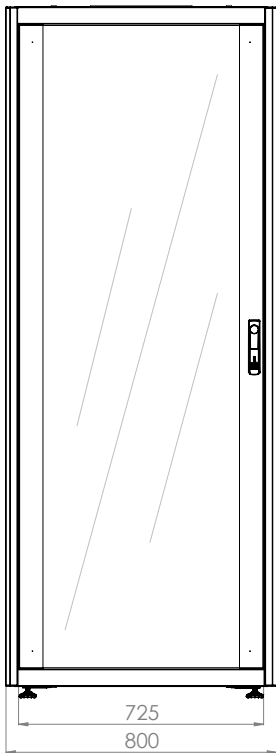

FRONT VIEW

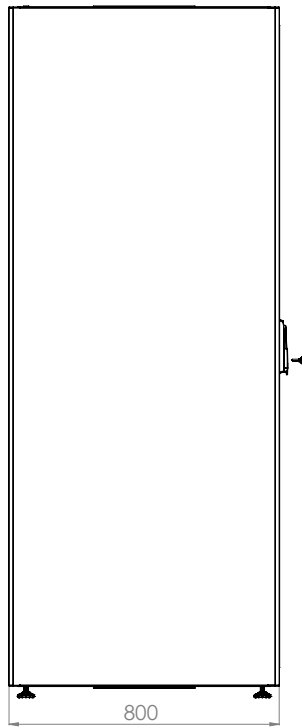

SIDE VIEW

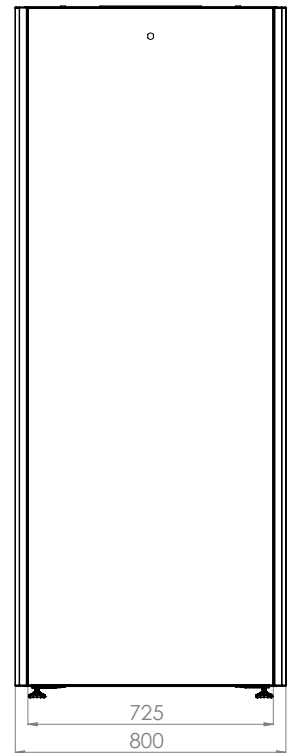

REAR VIEW

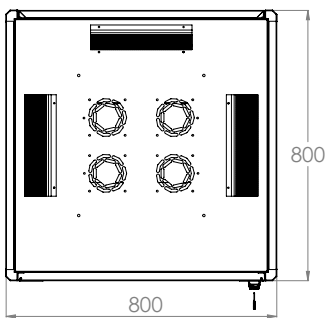

TOP VIEW

19" EURObox Cabinets

W:800mm D:800mm Drawings

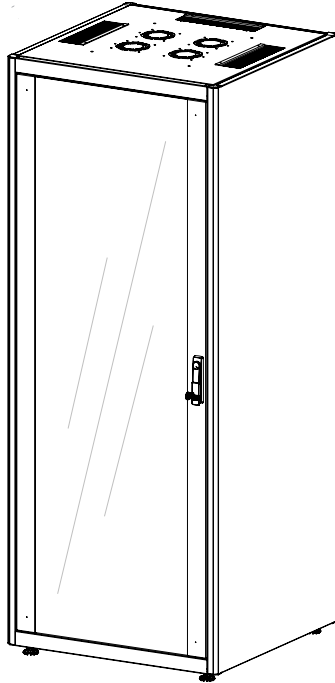

ISOMETRIC VIEW

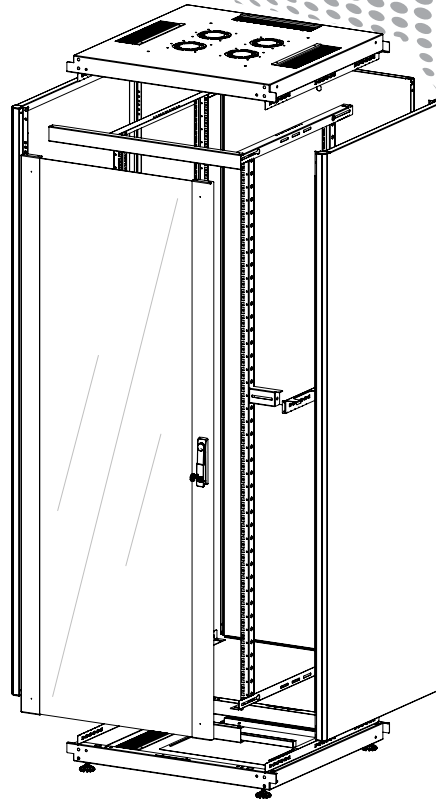

EXPLODED VIEW

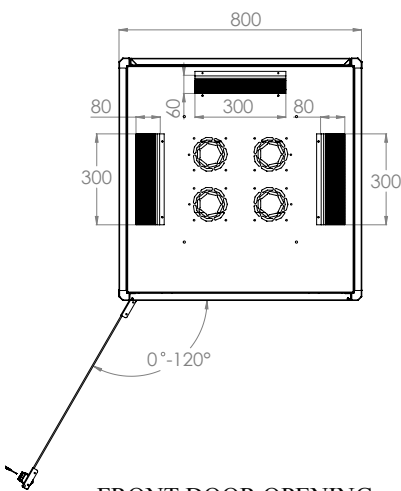

FRONT DOOR OPENING ANGLE

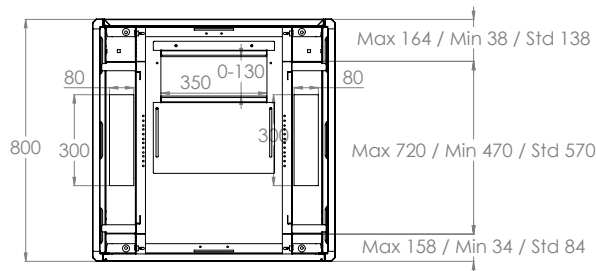

MAX/STD/MIN EQUIPMENT MOUNTING DISTANCE

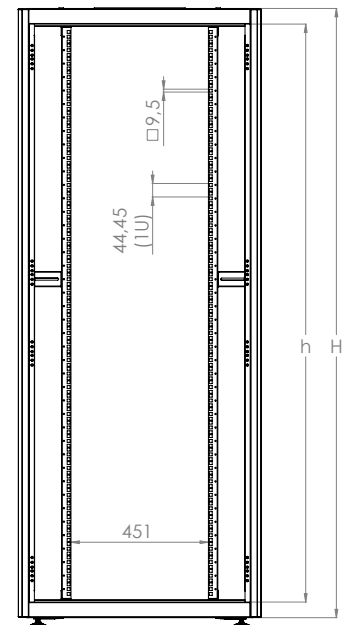

DIMENSIONS IN WIDTH AND HEIGHT

EURObox Series Free Standing 19" Cabinets W=800mm D=800mm

ROOT Product Number ***	Product Description	Size WxDxH mm	h size in U	h in mm	*H mm, overall without feet and/or castor	Width Overall mm	Width Rail to Rail	Depth Overall mm	**Depth Shipping Conf. Rail to Rail mm	QTY IN PACKAGE	PACKING DIMENSIONS WxDxH mm	Standard NET Weight of product kgs	Gross Weight of Product kgs	QTY IN PALETTE	PALETTE DIMENSIONS WxDxH mm	Palette Weight kgs
LN-EUBOX42U8080-LG	42U 19" Free Standing Cabinet W=800mm D=800mm	800x800x2010	42U	1867	2010	800	19"	800	570	1	2150x980x220	87	102	8	2150x1030x1950	725

*** Standard Supply is in Flat pack and RAL 7035 light Grey Color, incase requested Black put BL instead of LG, incase assembled product request, put A notification at the end of part number, ie LN-EUBOX42U8080-LG -A, unless defined light Grey-Flat pack product will be shipped

W=600mm D=1000mm EURObox Series Server Cabinets.

EURObox Free Standing cabinets are designed to perform for the best cost conduction to customers, with the strong and sturdy design, customer friendly assembly instructions, and superior logistical cost saving thanks to the intelligent flat packing mode.

Much more safer since not any detachable screw or hardware outside of cabinet.

The product is designed for network housing, in parallel functioning to mainly Servering and Storage applications.

While product gives maximum performance in parallel provides a very valuable economy compared to its quality which is based on high technologic fully automated industry.

The 600 series is available in 3 heights as 26U, 36U and 42U, with 1000mm depth. The wide product height portfolio meets any U requirement in infrastructure needs.

Each cabinet is supplied as standard with a %63 perforated single piece monoblock front and rear doors.

EURObox series Server Cabinets have a professional technical but aesthetic look with decorative %63 perforated honey comb pattern. The product range attracts the attention with the mostly environmentally fit and selected color of RAL 9005 Black, and RAL 7035 Light Grey, with fine wrinkle soft touch paint.

Completely standard and stocked product portfolio, being delivered as un-assembled in flat pack, as shipping configuration the adjustable feet group is included.

EURObox series server product range with optimal panel mounting size, and a variety range of accesories enclose the whole expectation of users.



CONSTRUCTION DETAILS:

Main Profile- Framework- Top/Bottom Cases and Roof:
Multi Folded Automated Bending technology applied monoblock side panel/frame system, provides a heavy duty structure results to high load capacity of: 600 kgs.

Monoblock multi folded top and bottom cases, tightly fixed to the side panel/frame system with fixing hardware , fully modular system generated.

Top case has a ready Forced Ventilation (Fan Module) integration housing.
Fan Module installation is from inside of enclosure

There are brushed cable entries on top for W600mm enclosures with 300x70mm

Bottom case integrated with Wide cable entry point provides maximum versatility. The rubber edged sliding mechanism on the cable entry point at bottom with w=350mmd=250mm allows large cabling infrastructure applications. On rubber edged sliding mechanism max cable entry opening is w=350xd=150mm. After inserting the cables, the rubber edged mechanism holds and fixes the cables in parallel preventing the cabinet from dust entry.

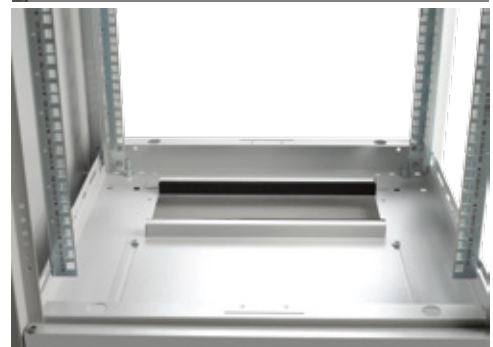
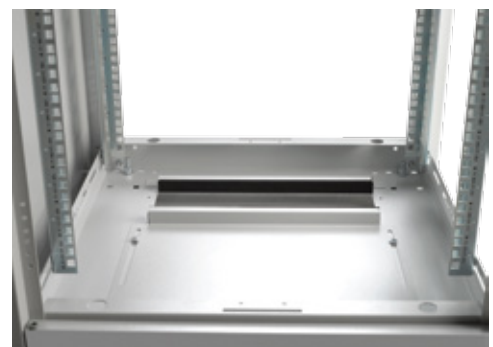
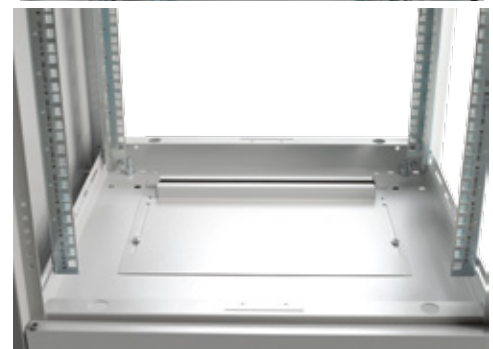

CONSTRUCTION DETAILS:

Access to enclosure:

Front door has a formed metal housing protecting the perforation pattern monoblock with single point locking handled lock.

Front door opening direction is set right to left, but reversible to left to right at site with removing the hinge system. Hinge System is spring loaded easy operating version, which allows you to remove the whole front door from cabinet in seconds.

Side Panels are main load carrying frame of the cabinets, which is fixed to the top and bottom cases. This provides the economical offer, customer friendly assembly from flat pack delivery.

Side panels are monoblock multi formed single piece metal panel, strengthened with the side horizontal support bars connection frame to the 19" rails.

Rear Panels are lockable and removable with barrel style lock, Multifolded bending technology with 8 fold bending provides the rigidity. For best optimized cost conduction to customers, the rear panel designed and created easy lift of design and snap locking to the bottom case.



Side and rear view of cabinet

CONSTRUCTION DETAILS:

19" rails of EURObox Series Free Standing cabinets are with automated silk-screen U numbering, depends on size 1U to 42U, same from top to bottom or bottom to top results to same U height selection. No matter from where you have started counting. 19" rails are 4 fold bending surfaces, 1,5mm thickness provides the high load capacities. The 19" rails are made of steel with 8-12 micron zinc plating for corrosion resistance. 19" rails are adjustable in depth. For easy adjustment purpose, no need to detach the screws, just ease the screws and slide them in the channels on the top/bottom chassis bends.



Side Horizontal Support Bar in depth; up to 26U the 19" rails are fixed to just to and bottom case. Higher than 26U the cabinets are integrated with 1 set (left/right), 1,5mm thickness Z type made of Steel + 8-12 micron zinc plated side horizontal support bar

All design features provide you strength and 2 way access to your enclosure and equipments, easy to reach to enclosure and equipments for all infrastructure installations and maintenance needs.



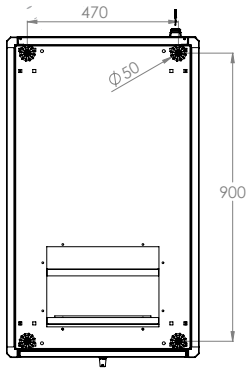

BOTTOM VIEW

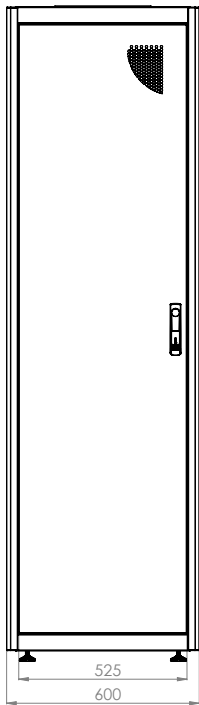

FRONT VIEW

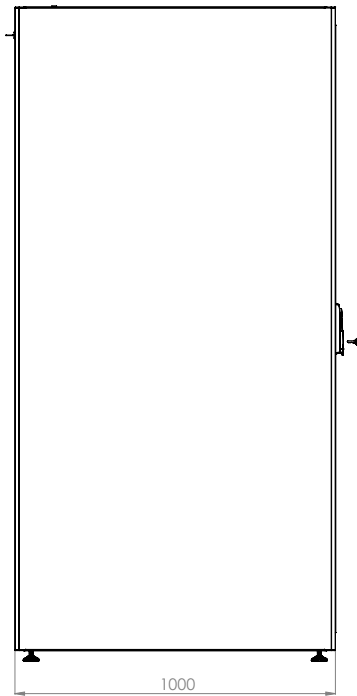

SIDE VIEW

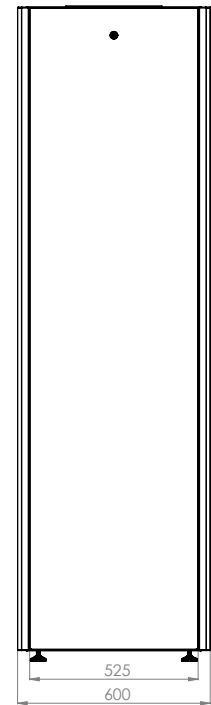

REAR VIEW

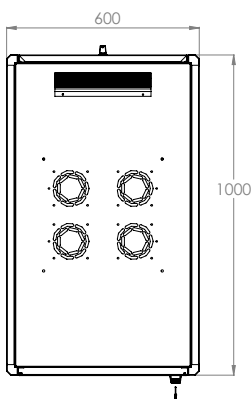

TOP VIEW

19" EURObox Server Cabinets

W:600mm- D:1000mm

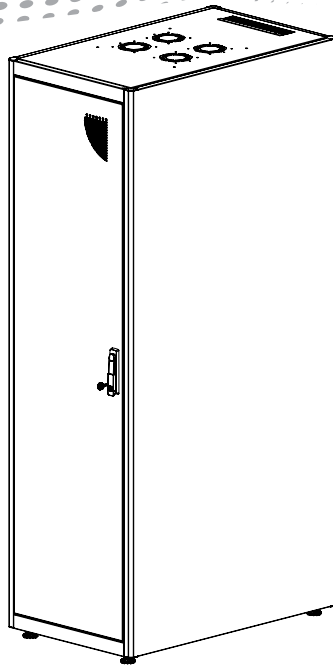

ISOMETRIC VIEW

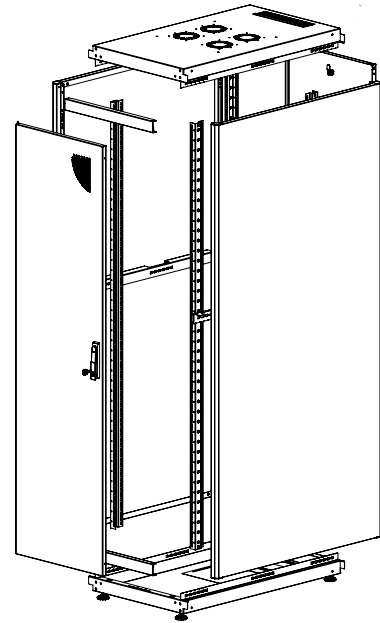

EXPLODED VIEW

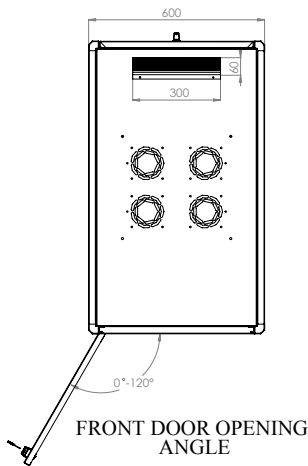

FRONT DOOR OPENING ANGLE

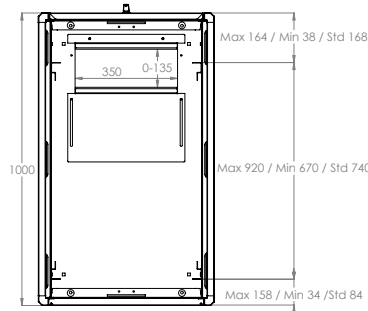

MAX/STD/MIN EQUIPMENT MOUNTING DISTANCE

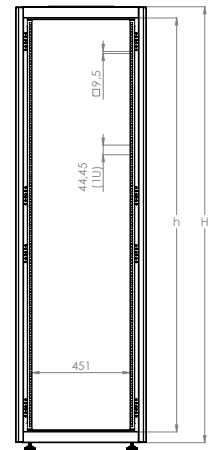

DIMENSIONS IN WIDTH AND HEIGHT

EURObox Series Free Standing Server 19" Cabinets W=600mm D=1000mm with

ROOT Product Number ***	Product Description	Size WxDxH mm	h size in U	h in mm	*H mm, overall without feet and/or castor	Width Overall mm	Width Rail to Rail mm	Depth Overall mm	**Depth Shipping Conf. Rail to Rail mm	QTY IN PACKAGE	PACKING DIMENSIONS WxDxH mm	Standard NET Weight of product kgs	Gross Weight of Product kgs	QTY IN PALETTE	PALETTE DIMENSIONS WxDxH mm	Palette Weight kgs
LN-EUBOXES26U6010-LG	26U 19" Free Standing Cabinet W=600mm D=1000mm Perforated % 63 front and rear doors	600x1000x1300	26U	1155	1300	600	19"	1000	770	1	1520x1140x240	62	74	6	1520x1170x1600	390
LN-EUBOXES36U6010-LG	36U 19" Free Standing Cabinet W=600mm D=1000mm Perforated % 63 front and rear doors	600x1000x1743	36U	1600	1743	600	19"	1000	770	1	1830x1140x240	76	81	6	1830x1170x1600	476
LN-EUBOXES42U6010-LG	42U 19" Free Standing Cabinet W=600mm D=1000mm Perforated % 63 front and rear doors	600x1000x2010	42U	1867	2010	600	19"	1000	770	1	2150x1140x240	85	105	6	2150x1170x1600	545

*** Standard Supply is in Flat pack and RAL 7035 light Grey Color, incase requested Black put BL instead of LG, incase assembled product request, put A notification at the end of part number, ie LN-EUBOXES26U6010-LG-A, unless defined light Grey-Flat pack product will be shipped

WHY FLAT PACK; WHAT MAKES SENSE in EURObox!

Delivery of EURObox, configured as Flat Pack for reducing cost of logistics , comparatively 3 times higher qty can be stacked in transport vehicles which allows 3 times less logistical cost.

Customer friendly assembly, fully modular construction, zero risk of error design for customer assembly (all potential assembly mistakes are avoided), less operation and labour cost while assembly operation to be performed.

Allowing better cost scheme in projects, since the infrastructure installer or customer might operate the assembly operation at site. Thus narrow doors, unavailability of goods-hoist and staircases are no more a problem.

No special assembly tool required.

Re-used Packing Material after assembly incase a second step delivery to be operated.

Second Step delivery from distributor/partner to the end user or reseller is possible, allowing long distance second step delivery. Therefore product is packed with cardboard protection and overall wooden crate packing.



19" EURObox Free Standing and EURObox Server Cabinets Frequent Used Accessorry Selection Chart



Frequent Used Accesories EURObox Free Standing and Server Cabinets Sizes w:width mm d:depth mm				
	w:600xd:600	w:600xd:800	w:600xd:1000	w:800xd:800
Fixed Shelves compatible with only Lande cabinet	LN-RAF-SBT-D600-CC	LN-RAF-SBT-D800-CC	LN-RAF-SBT-D100-CC	LN-RAF-SBT-D800-CC
Fixed Shelves Universal Mutivendor	LN-RAF-SBT-D600-CC-UNV	LN-RAF-SBT-D800-CC-UNV	LN-RAF-SBT-D100-CC-UNV	LN-RAF-SBT-D800-CC-UNV
Heavy Duty Fixed Shelves	-	-	LN-RAF-SBA-D100-CC	-

**CC is color code: please insert BL for Black and LG for Light Grey on the part numbers while creating order



Frequent Used Accesories EURObox Free Standing and Server Cabinets Sizes w:width mm d:depth mm				
	w:600xd:600	w:600xd:800	w:600xd:1000	w:800xd:800
Sliding Shelves	LN-RAF-HRK-D600-CC	LN-RAF-HRK-D800-CC	-	LN-RAF-HRK-D800-CC
Heavy Duty Sliding Shelves	-	-	LN-RAF-HRA-D100-CC	-

**CC is color code: please insert BL for Black and LG for Light Grey on the part numbers while creating order



Frequent Used Accesories EURObox Free Standing and Server Cabinets Sizes w:width mm d:depth mm				
	w:600xd:600	w:600xd:800	w:600xd:1000	w:800xd:800
2 fan Units on/off switched	LN-FAN-ONF-2FFS-CC	LN-FAN-ONF-2FFS-CC	LN-FAN-ONF-2FFS-CC	LN-FAN-ONF-2FFS-CC
2 fan Units with Thermostatic control Unit	LN-FAN-THM-2FFS-CC	LN-FAN-THM-2FFS-CC	LN-FAN-THM-2FFS-CC	LN-FAN-THM-2FFS-CC
4 fan Units on/off switched	LN-FAN-ONF-4FFS-CC	LN-FAN-ONF-4FFS-CC	LN-FAN-ONF-4FFS-CC	LN-FAN-ONF-4FFS-CC
4 fan Units with Thermostatic control Unit	LN-FAN-THM-4FFS-CC	LN-FAN-THM-4FFS-CC	LN-FAN-THM-4FFS-CC	LN-FAN-THM-4FFS-CC
Horizontal Cable Management Panel 19" 1U 5 rings	LN-KDG-YKD-1UKN-CC	LN-KDG-YKD-1UKN-CC	LN-KDG-YKD-1UKN-CC	LN-KDG-YKD-1UKN-CC

**CC is color code: please insert BL for Black and LG for Light Grey on the part numbers while creating order



Frequent Used Accesories EURObox Free Standing and Server Cabinets Sizes w:width mm d:depth mm				
	w:600xd:600	w:600xd:800	w:600xd:1000	w:800xd:800
Vertical Cable Manager	-	-	-	LN-KDG-ORG-xxEU-CC

** CC= Color Code, LG Light Grey RAL 7035, BL Black RAL 9005, customers to define while ordering.

***XX is the U height of Vertical cable manager, according to selected height of cabinet, please define U height while creating order.



Frequent Used Accesories EURObox Free Standing and Server Cabinets Sizes w:width mm d:depth mm				
	w:600xd:600	w:600xd:800	w:600xd:1000	w:800xd:800
Caster Group 2 w/breakes 2 wo/breakes	LN-ZMN-TKR-5525-XX	LN-ZMN-TKR-5525-XX	LN-ZMN-TKR-5525-XX	LN-ZMN-TKR-5525-XX



Frequent Used Accesories EURObox Free Standing and Server Cabinets Sizes w:width mm d:depth mm				
	w:600xd:600	w:600xd:800	w:600xd:1000	w:800xd:800
PDU 6 way Schuko with 1x16A cct breaker	LN-PRZ-SGT-1U6P-SC	LN-PRZ-SGT-1U6P-SC	LN-PRZ-SGT-1U6P-SC	LN-PRZ-SGT-1U6P-SC



Frequent Used Accesories EURObox Basic Series Free Standing Cabinets Sizes w:width mm d:depth mm				
	w:600xd:600	w:600xd:800	w:600xd:1000	w:800xd:800
Mounting Hardware, Fixing M6 Cage nut set of 20	LN-DGR-KFS-M620-XX	LN-DGR-KFS-M620-XX	LN-DGR-KFS-M620-XX	LN-DGR-KFS-M620-XX